

Imported by Amart Furniture Pty Ltd, Qld, Brisbane Australia.  
For any assistance with assembly or for missing parts please  
phone Amart Furniture, Customer Service Free Call  
1800 351 084

# PRE-ASSEMBLY PREPARATION

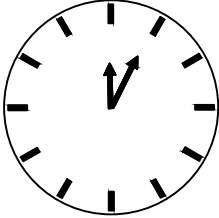

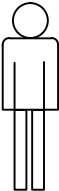



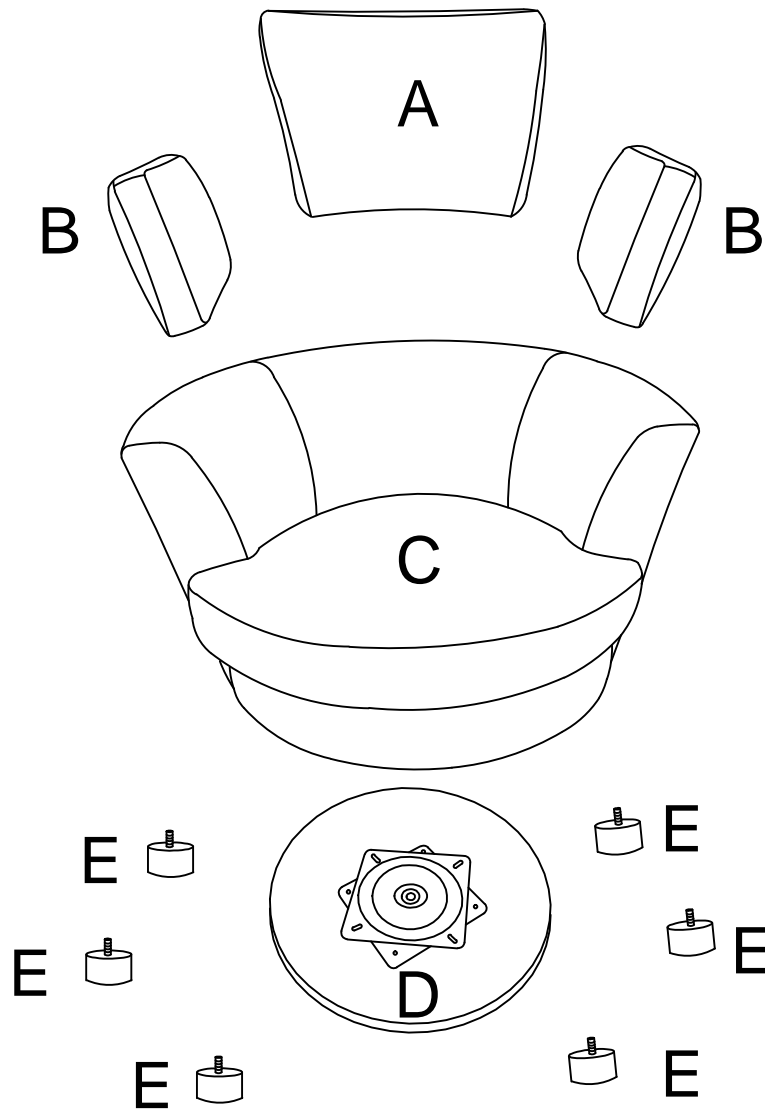

## Before you start:

1. Choose a clean, level, spacious assembly area. Avoid hard surfaces that may damage the product
2. Take care when lifting. Product should be assembled as near as possible to the point of use
3. Ensure that you have all required contents for complete assembly
4. Always read the assembly instructions carefully before beginning assembly
5. Keep all hardware parts and packaging out of small children
6. Do not over tighten the screws and bolts as this may damage the threads

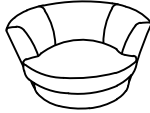
	
ALLOW 5 MINUTES	2 PEOPLE REQUIRED

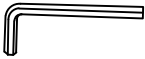
# PARTS LIST



A.1PC  Backrest	B.2PC  Armrest	C.1PC  Seat	D.1PC  Chassis	E.6PC  Leg
F.1PC(M5*100mm)  Allen Key	G.4PC(M8*40mm)  Bolt	H.4PC(M8)  Spring Washer	I.4PC(M8*19mm)  Flat Washer	

# STEP 1

Flip sofa (C) so that its bottom side is up, then place rotary table (D) on (C) and align the screw hole. Use spring washer (H) flat washer (I), and bolt (G) as shown below, then tighten with allen key (F).

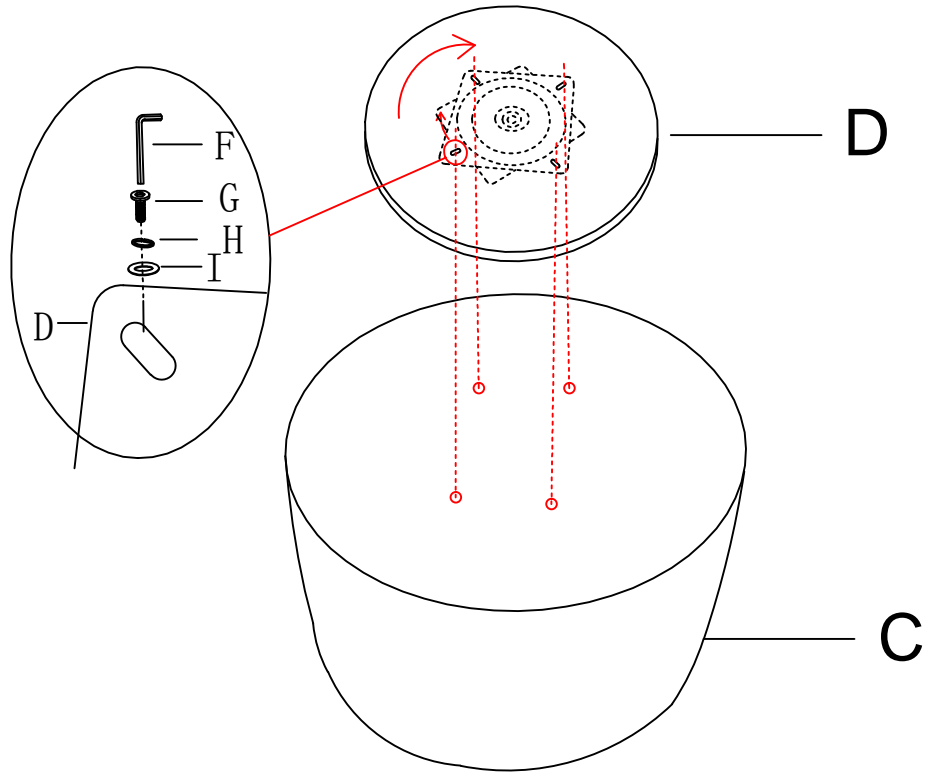

# STEP 2

Align the sofa leg (E) to the screw hole of the turntable (D) and tighten it

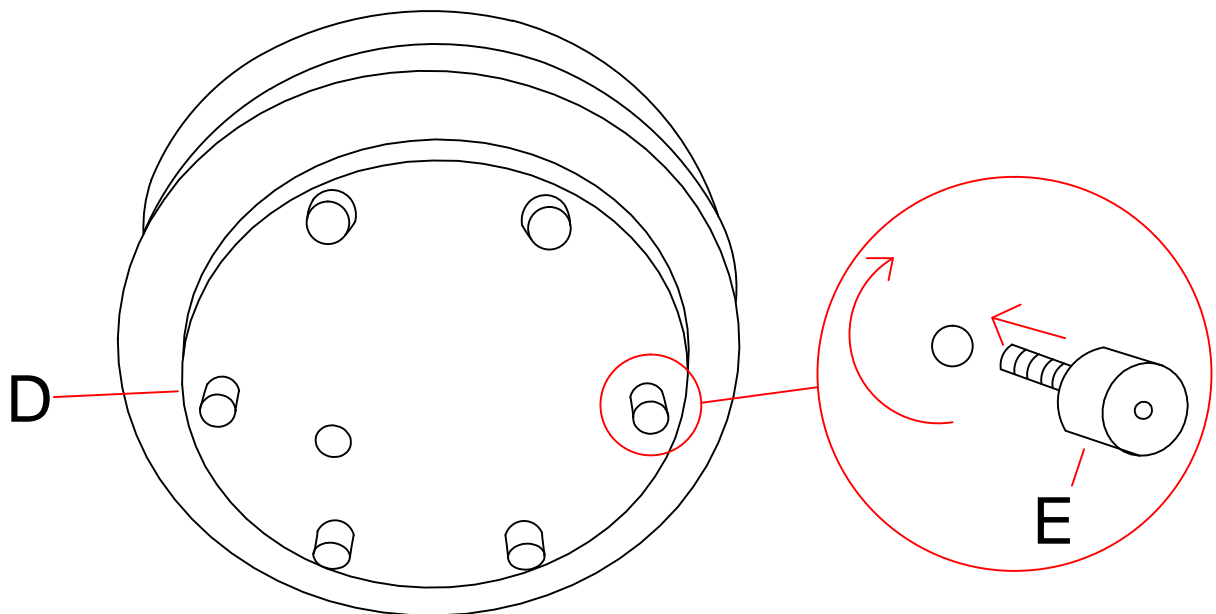

**STEP 3** As shown in the figure, arrange the backrest in turn (A) and (B).

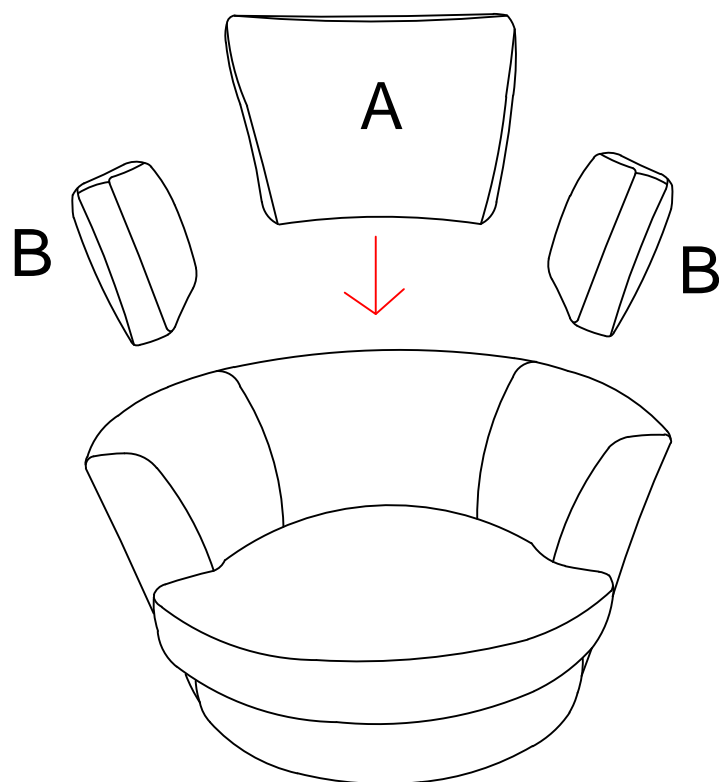

**ASSEMBLY IS COMPLETE**

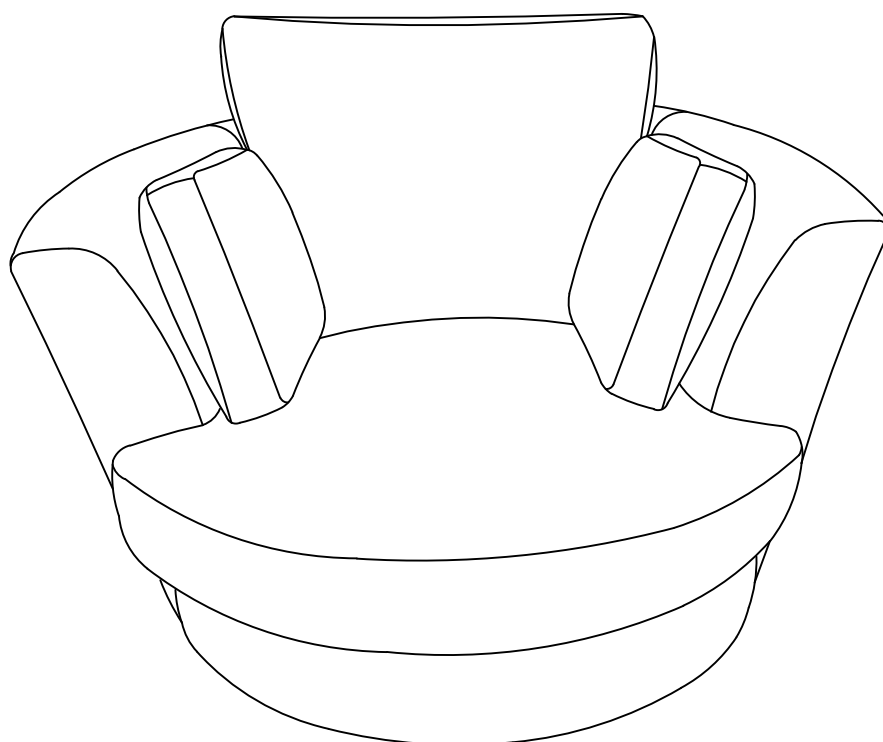

# Fabric Care and Maintenance



## REGULAR CARE:

- Protect from direct sunlight

• Avoid using harsh cleaning agents or solvents on the fabric.

## CLEANING:

• If the fabric has zippers, they may have zippers

• Use a mild detergent to clean the fabric.

• Recommended cleaning method: Use a mild detergent and warm water to clean the fabric.

• Do not use bleach or other harsh cleaning agents.

• Avoid using steam cleaning.

• Do not use dry cleaning.

• Avoid using fabric softeners.

• Do not use ironing.

## SPOT CLEANING:

• Blot the stain immediately.

• Use a mild detergent and warm water to clean the stain.

• Do not rub the stain.

• Do not use harsh cleaning agents or solvents on the fabric.

• Remove the residue of the spill

• Do not saturate the fabric or interior with water or other cleaning liquids

## WARNING:

Apply only water-based soil resist (fabric protection) treatments. Do not use aerosol products

\* PILLING IS NOT A FABRIC DEFECT OR FAULT AND IS NOT COVERED BY WARRANTY

\* PILLING IS A NORMAL OCCURRENCE CAUSED BY WEAR AND TEAR AND DOES NOT AFFECT THE DURABILITY OR FUNCTIONALITY OF THE FABRIC AND IS EASILY REMOVED